

A New Experience In Big Data Analytics

Mobigen

Company Introduction

Big Data, AI & Next-generation Network Company

www.mobigen.com

A software company specialized in big data, AI and the next-generation network operation fields

Mobigen by the Numbers

Establishment

2000

Employees

240+

Patents Issued

15+

Clients

50+

Annual Revenue FY23

\$22M

CAGR

11 %

A software company specialized in big data, AI and the next-generation network operation fields

Annual Revenue for the Last 3 Years & Future Targets

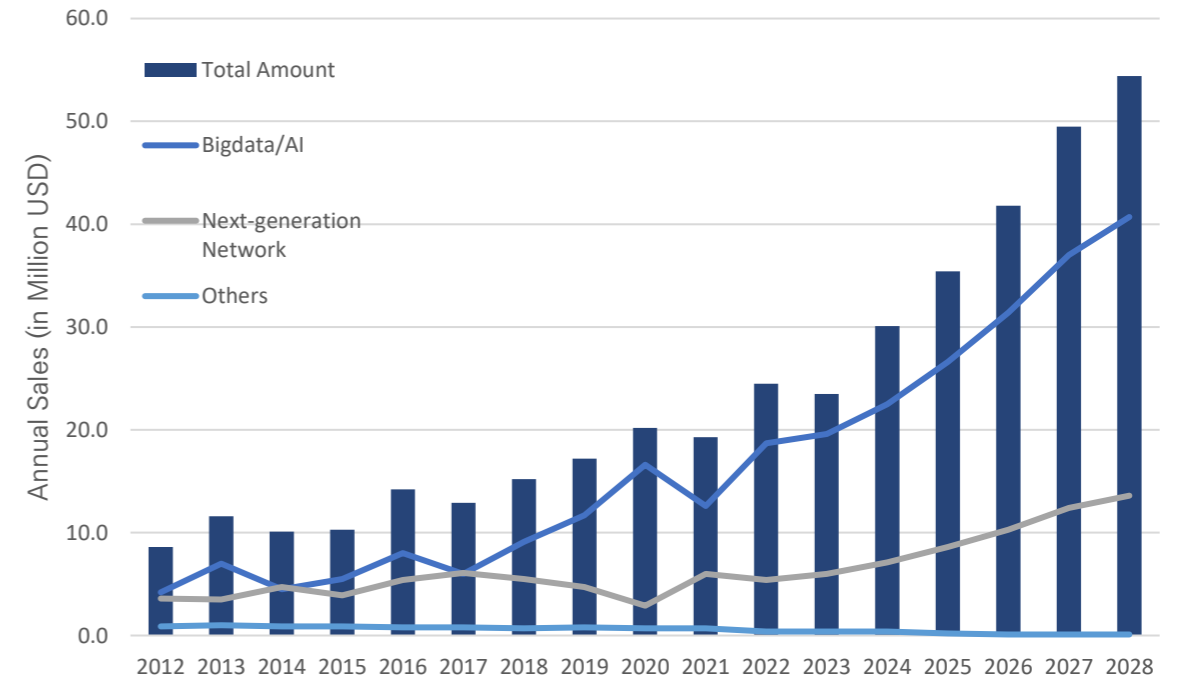
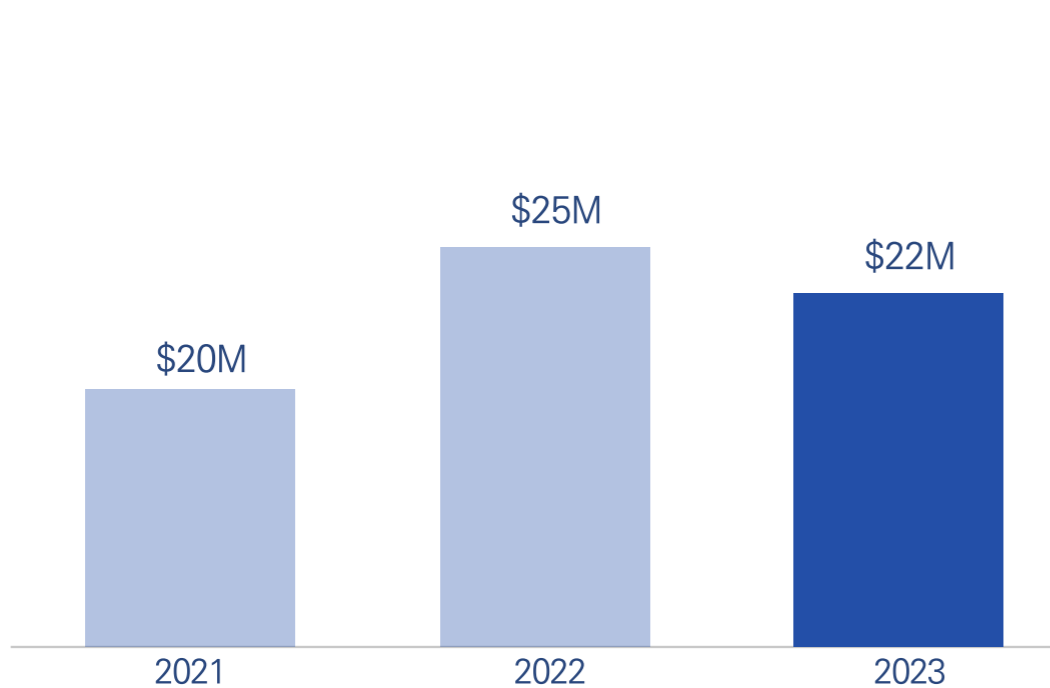

A technology-driven software company where more than 80% of the total workforce is comprised of research and development personnel

Organization Chart

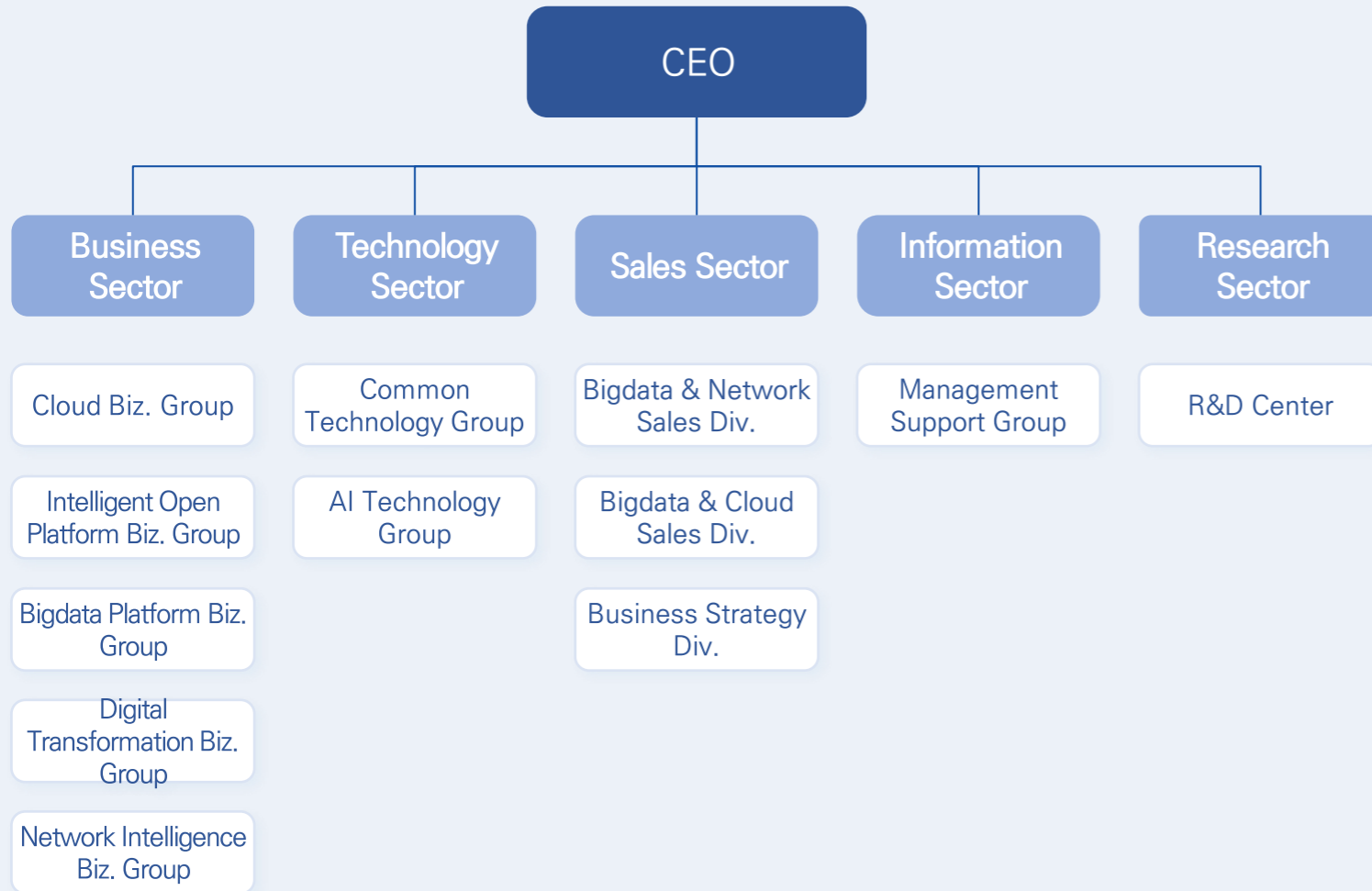

Personnel Composition



Product & Solution Portfolio based on Key Technologies in OSS and Bigdata/AI fields

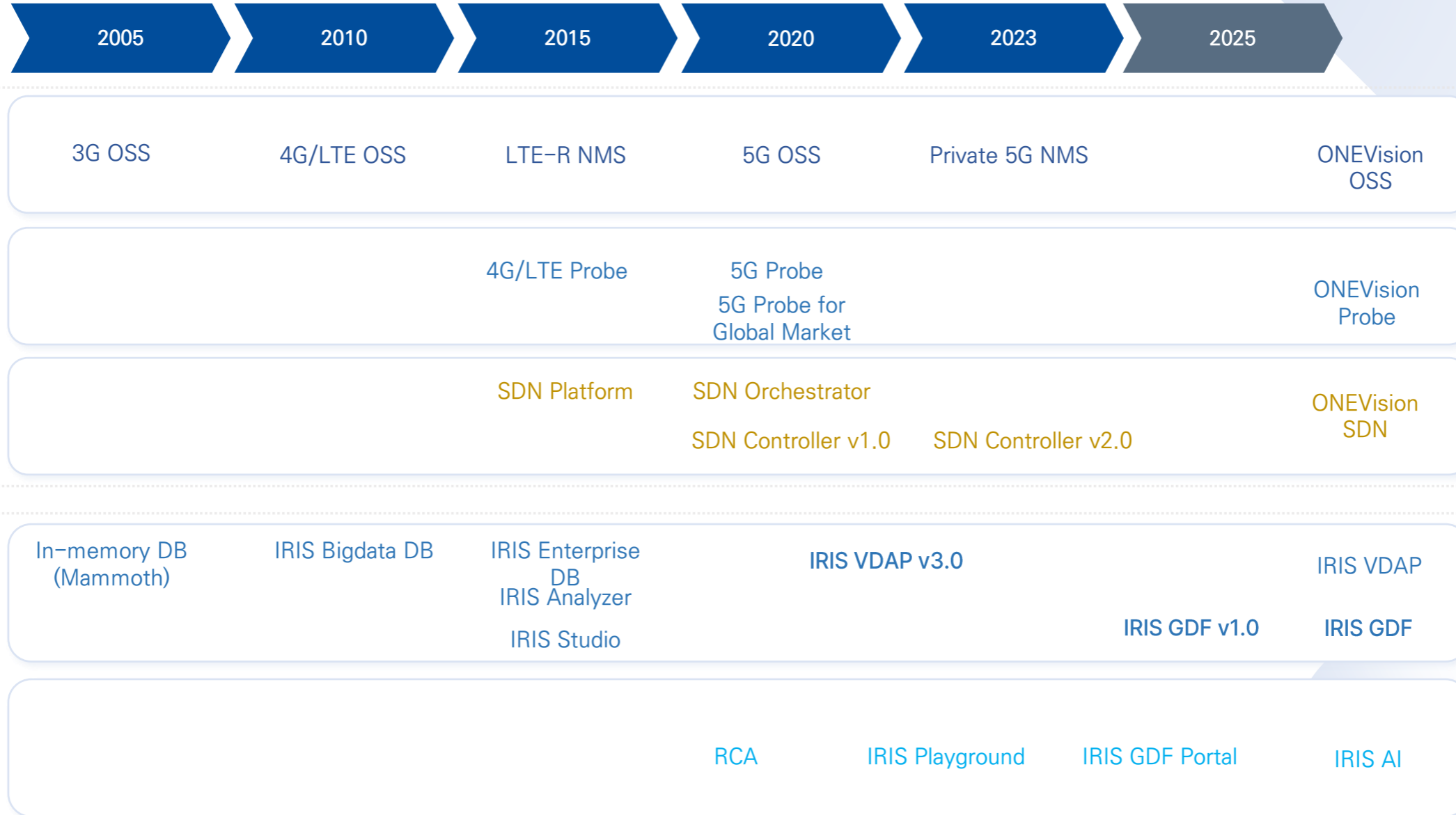

AI xOps

- IT Operations
- Data Operations
- ML Operations
- Network Operations
- ⋮

* OSS(Operations Support Systems), SDN(Software Defined Networking), VDAP(Visual Data Analysis Platform, GDP(Gen AI Data Fabric)

Large-capacity, high-performance Bigdata-AI platform product line – IRIS

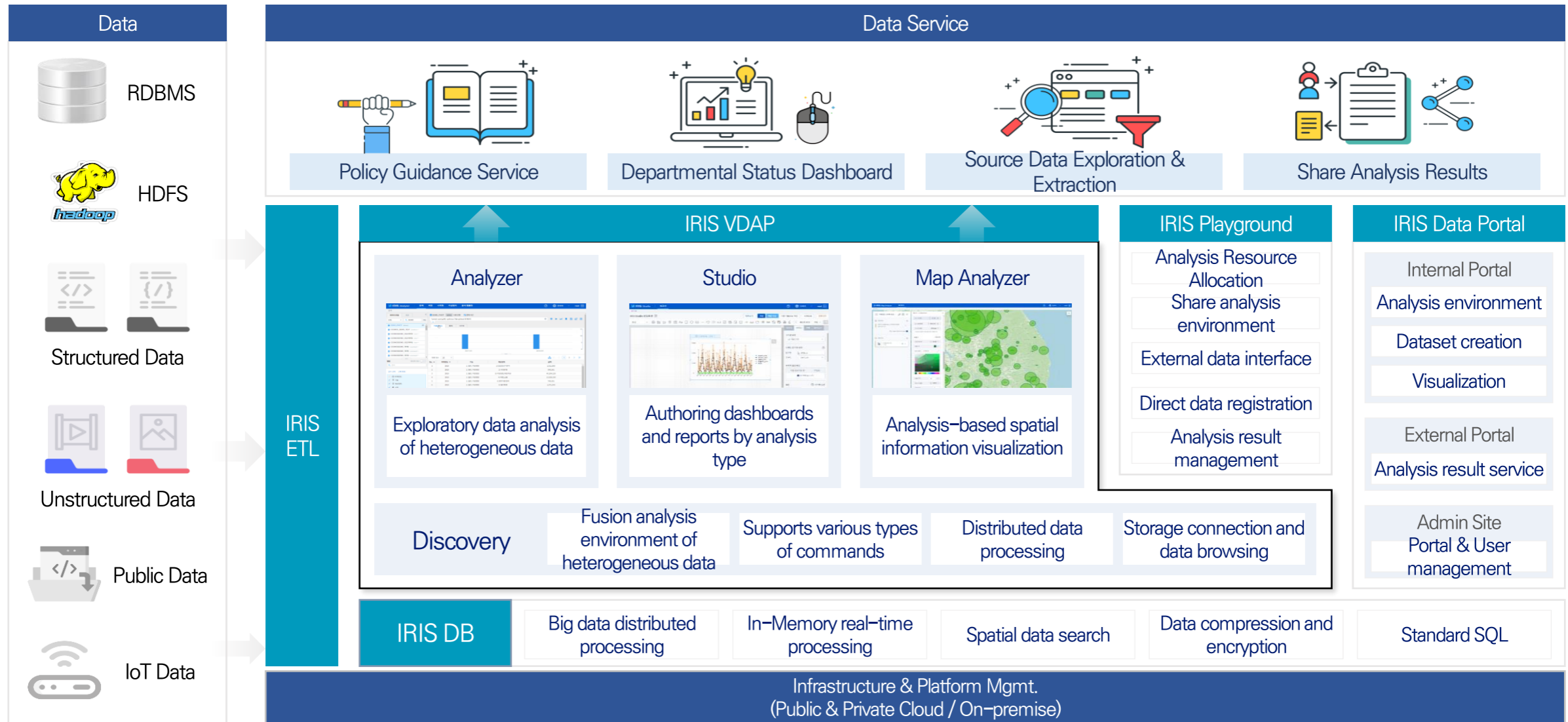

Good Data for AI, Mobile Packet Probe Solution - ONEVision Probe

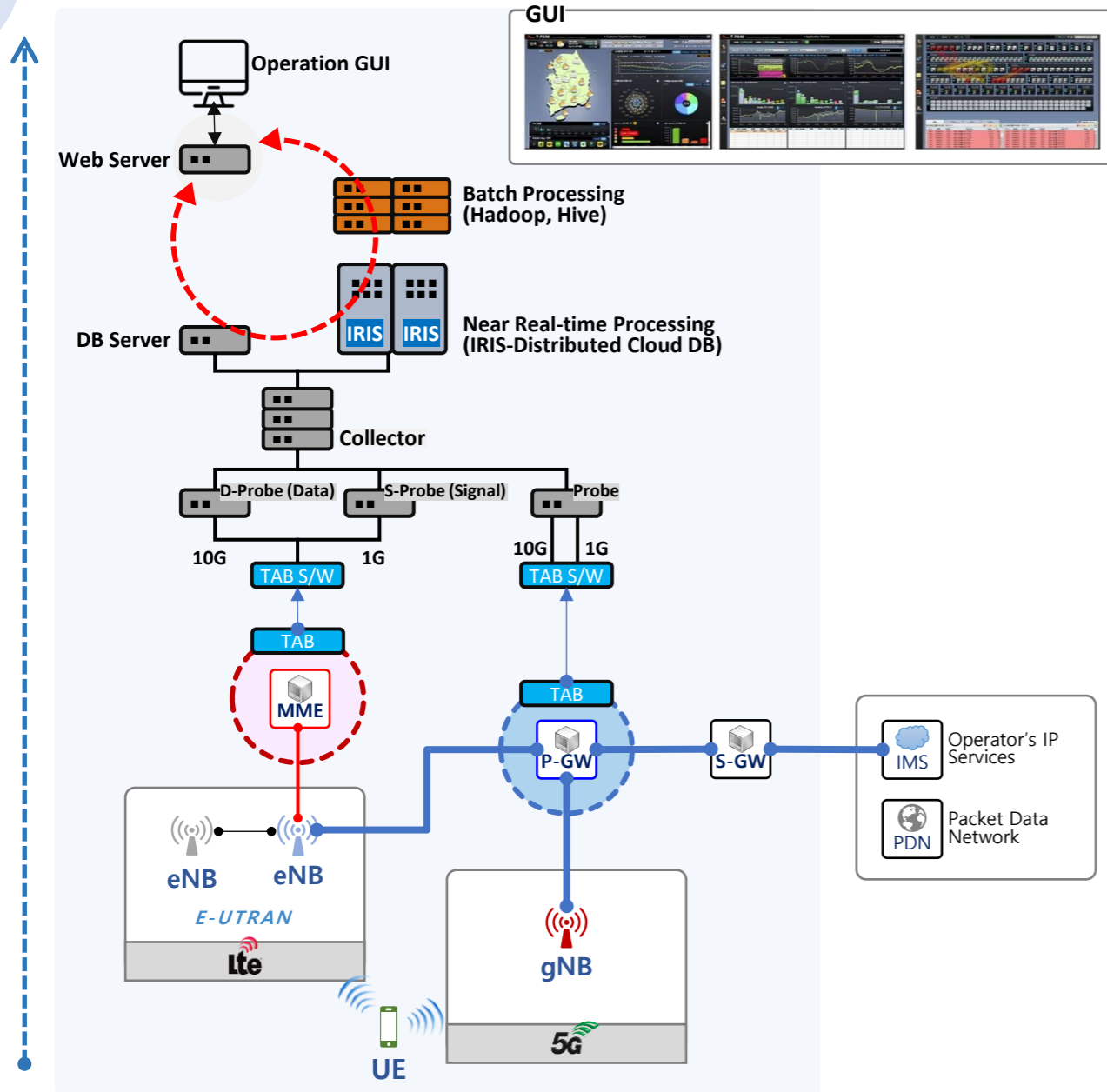

1. Providing over 10 years operating services for No.1 Mobile Carrier in Korea (SKTelecom)
2. Operating communications quality management base on customer experience index(CEI) (SKT ranked No.1 in service quality for 10 consecutive years)
3. Protect customers from cybercrime by analyzing usage patterns
4. Effective cost savings through deep analysis of traffic (Minimize interconnect traffics, Reducing CSP costs)
5. Provide high-value data for sale, such as customer spending and potential hotspots for new stores, and key data for AI-driven operational automation
6. Largest data processing and analytics company in Korea (150 billion records/day)

Multi-Vendor/-Layer based SDN solution

Multi Layer/Vendor SDN NW & Service Automation(NetOps, NaaS*1)

T-SDN Controller
(WDM, ROADM, OTN, PTN)

IP-SDN Controller
(IP/MPLS, L3/L2)

DC-SDN Controller
(Spine/Leaf, NAT, DCGW)

NFV Infra
(VNF)

North Bound API (Internal/External)

Model-Driven Service Abstraction Layer(MD-SAL) for Multi-Vendor/-Layer/-Domain Environment

South-Bound Interface(SBI) Plugins (Protocol Adaptation)(OpenFlow, SSH, NETCONF, SNMPv3 등)

Data Store
(RDBMS,
Big Data)

South Bound Interface

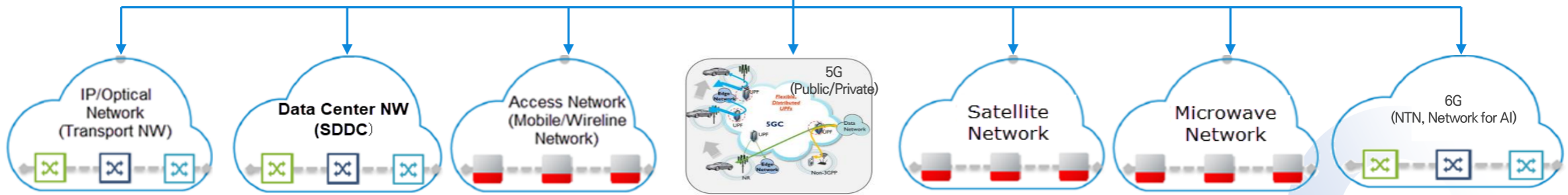

SDN 적용

2015년

2010년

2025년

2030년

*1) NaaS: Network-as-a-Service, 사용자 정의(동적) 네트워킹 서비스

Our Key Customers



Thank You

mobigen
Make The Best For Smart Business

 37, Geumto-ro 80beon-gil, Sujeong-gu, Seongnam-si, Gyeonggi-do, Korea, 13453

 +82-2-538-9360 FAX +82-2-538-9396

 sales@mobigen.com

 www.mobigen.com/eng